

إبس
Aluminium EPS

مصنع في السعودية
Made in K.S.A

رؤية
VISION
2030
المملكة العربية السعودية
KINGDOM OF SAUDI ARABIA

EPS KITCHEN

ALUMINIUM AND WOOD-GRAIN PERFECTION

فخر الصناعة السعودية

إيس للألمنيوم
Aluminium EPS
صنع في السعودية Made in K.S.A

Evaluations that Happened to Kitchen Cabinet

نبذة عن الشركة

مصنع إيس للألمنيوم هو إحدى شركات مجموعة الطابع المتخصصة في المجالات التجارية والمشاريع في المملكة العربية السعودية والخليج العربي و هي من الشركات الرائدة في السوق السعودي والتي تدار عن طريق فريق من الموظفين الأكفاء المختصين في المجال التجاري والصناعي ، كما انها من الشركات التي اتبعت سياسات مدروسة منذ انطلاقتها الأولى عام ٢٠٠٩ م ، وارتكزت تلك السياسات على أسس علمية وحلول واقعية مدروسة ، وقد تفردت الشركة بوجود طموح يتنامى بشكل كبير، لتحقيق الإنجازات الكبرى، والمضي في إستراتيجية عمل مرنة، تسعى لتحقيق الريادة الشاملة في قطاع الصناعة و الواجهات الزجاجية للمباني و شبائك الألمنيوم و الأبواب ، كما تخصصت بمطابخ الألمنيوم ذات جودة عالية وهو ما يقودنا لضرورة الحفاظ على البصمة المميزة في إدارة وتنفيذ المشاريع الهامة والكبرى، الأمر الذي يعكسه حجم المشاريع التي تم إنجازها خلال السنوات الماضية نحن دائماً يشرفنا و يسعدنا تقديم خدماتنا للشركات و المؤسسات و المواطنين داخل المملكة و خارجها .

وتفضلوا بقبول فائق التحية والاحترام

The Kitchen is the heart of the home. Having a well-designed kitchen allows you to complete tasks easily, efficiently and enjoyable. One of the most significant elements of your dream kitchen is definitely the Kitchen cabinets. A professional high-value kitchen cabinetry design include aesthetics as well as functionality.

EPS Co. Kitchen Cabinet is brilliantly designed and developed for today's lifestyle and your personal specifications. It features ideal panel thickness, adjustable shelves, strong drawer construction, attractive door finish, rounded inner edge and soft close hinges that all exceeding your expectations for best cabinetry.

EPS Co. Provides a wide selection of door finishing. Find ideas and inspiration from our large array of panel designs to bring your dream kitchen to reality.

INTELLECTUAL PROPERTY NOTICE

All trade mark in this catalogue, unless otherwise indicated, are subject to the trade mark rights of EPS Co. or its related parties and are registered trade marks in Saudi Arabia and other countries. EPS Co. or its related parties protect their marks, brands, model names and logos in all countries in which it uses them.

Certain features and/or functionality of the products and/or systems of EPS Co. or its related parties as described in this catalogue are the subject matter or patent applications pending before the Intellectual Property Corporation of Saudi Arabia.

The shape, configuration, pattern and/or ornament of the designs applied onto the products found in the catalogue have, where permissible, been protected by way of registered industrial designs in Saudi Arabia by EPS Co. or its related parties.

All materials, including texts, images, logos, designs, graphics, photographs, and other materials that appear as part of this catalogue are properties owned or licensed by EPS CO. or its related parties, and are protected by copyright or other intellectual property laws all around the world, and all such rights are reserved. The contents of this catalogue, and the catalogue as a whole, may not be scanned, reproduced, adapted, modified, published, or distributed, in whole or in part, without the prior written consent of EPS Co. or its related parties.

EPS Co. or its related parties views matters relating to its intellectual property rights and interest seriously and will take the necessary actions to protect and enforce its rights third parties found to be infringing its. Rights.

Full Aluminium Cabinet Series

& Semi Aluminium Cabinet Series >>





Full Aluminium Cabinet Series

EPS Full Aluminium Kitchen Cabinet fully displays the aluminium's attractive properties including exceptional flexibility and proven life-time Performance. It is designed for aesthetically pleasing appearance and excellent durability.

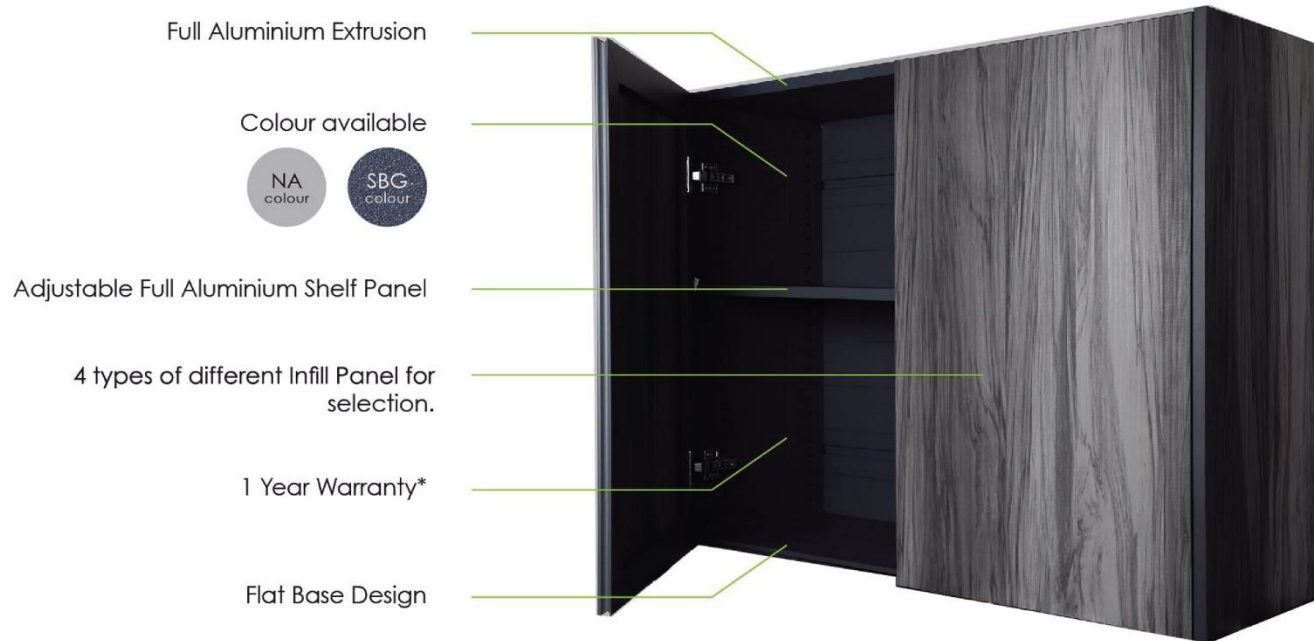

* One year limited warranty subject to the terms and conditions set forth.



Semi Aluminium Cabinet

EPS Semi Aluminium Cabinet series reveals the essence of best kitchen cabinet while emphasizing on its complexity. You will definitely get Inspired by our countless panel designs and find the ideal solutions that perfectly define your kitchen space.



* One year limited warranty subject to the terms and conditions set forth.

Personal Touch & Designer Style

Attractive Door Finishing

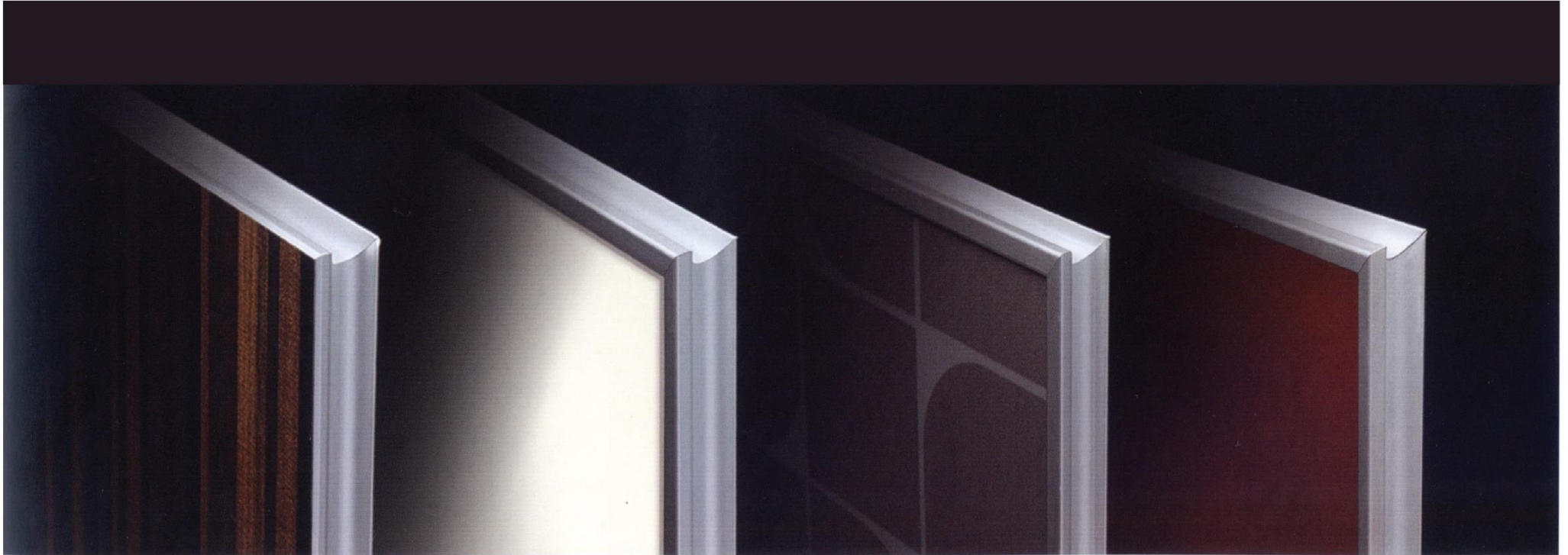

No matter what your particular design preference, EPS Co. offers a unrivalled array of infill panel designs that work with every design and theme.



Custom Width

In order to provide you with the perfect cabinet solution for your kitchen, the width of the cabinet can be adjusted and customized.

Base Cabinet 2 Doors

232D (Full) / 232C (Semi)



Custom Width

(Min) 450mm - (Max) 900mm

Wall Cabinet Corner with 1 Doors (right)

292G (Full) / 292E (Semi)



Fixed Size
352mm

Custom Width
(Min) 600mm - (Max) 1052mm

Handle-less Doors



Once considered a niche design feature, handle-less kitchens have grown in popularity, fueled by an increasing demand for contemporary styles, minimalist looks and the need to maximize space. Handle-less cabinets are versatile, accommodating and timeless. Cabinet and drawer handles today are a choice rather than a necessity. Opting for a handle-less design creates a streamlined flow of kitchen units that's beautiful as well as efficient. The resulting look is chic, clean and clutter-free. The benefit of grabbing the back of the door is that you don't need to touch the front, so there shouldn't be any fingerprints.

Kitchen Layout Design

The Work Triangle is an important design concept for an optimal relationship between the sink, refrigerator and primary cooking surface. Although there are endless various and elaborations for work triangle application, most kitchens fall into one of these models.



I-Shaped / Single-wall kitchen

I-Shaped / Single-wall kitchen in a single-wall kitchen, cabinets and appliances are fixed along one wall. This option is space-saving, perfect for apartments or small homes. The work triangle is just a work line in this example, so works stations must be carefully considered and spaced appropriately. For increased storage, go vertical. Stack cabinets to the ceiling to maximize space.



Parallel / Galley kitchens

Parallel / Galley kitchens are two parallel walls with a walk-through between them. It is an efficient use of space for small, narrow kitchens. With no custom corner cabinets to worry about, this can be a cost-effective option for projects on a budget. Work station placement should be carefully considered, as galley kitchens can become a crowded thoroughfare.



L-shaped kitchen

The most popular choice for kitchen layout design is an L-shape. An l-shaped kitchen is two adjoining walls that are perpendicular to each other. They are an ideal option for kitchens located in a corner space, particularly if they open up into another room. L-shaped kitchens are a great choice for any sized kitchen. This layout optimizes the flow of traffic. Corner cabinets can be customized depending on the space available. Enhance an l-shaped kitchen by adding an island, a breakfast nook, or a walk-in pantry.

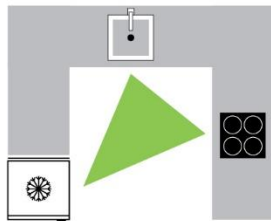

U-shaped kitchen

U-Shaped kitchens have three connected walls of cabinets and countertop space. The main benefit of this type of kitchen is an additional wall for storage. A U-shaped kitchen is best for a large kitchen, as a small U-shaped kitchen can feel closed-in. Including open shelving or a large hood and backsplash area on one of the walls can help open up the space.

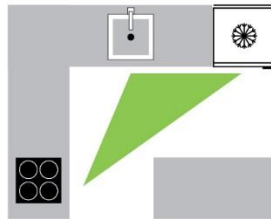

Island kitchen

Island kitchens are quickly becoming the most popular style of kitchen remodel. Islands are often an addition to a single-wall or an l-shaped kitchen to maximize functionality. There are numerous benefits to adding an island – increased storage, more countertop space, and eat-in options – just to name a few. The kitchen island is the new command center of the room, provided you have the space for one.

Types of Model

Base Cabinet

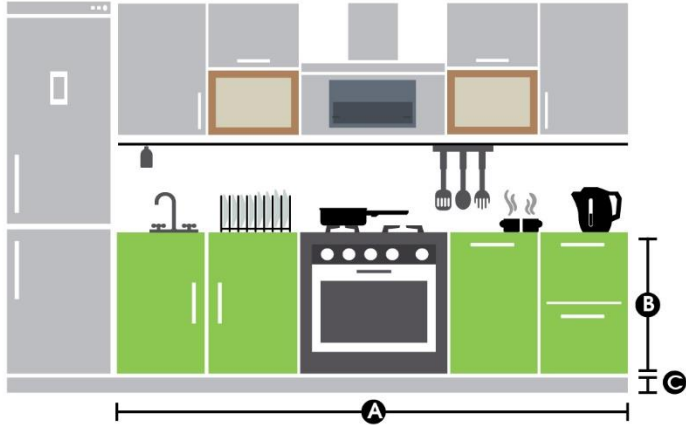

- A** Width : Custom Size
- B** Height : 760 mm
- C** Bottom Skirting Board (H) : 100mm



- 1** 1 Door
231D (Full) / 231C (Semi)

Product Size

Width (W) : (Min) 450 - (Max) 600 mm
Depth (D) : 587 mm
Height (H) : 760 mm



- 2** 2 Door
231D (Full) / 231C (Semi)

Product Size

Width (W) : (Min) 600 - (Max) 900mm
Depth (D) : 587 mm
Height (H) : 760 mm



- 3** 1 Door + 1 Drawer
231D (Full) / 231C (Semi)

Product Size

Width (W) : 450 / 600 mm
Depth (D) : 587 mm
Height (H) : 760 mm



- 4** 2 Door + 1 Drawer
234D (Full) / 234C (Semi)

Product Size

Width (W) : 600 / 900 mm
Depth (D) : 587 mm
Height (H) : 760 mm



- 5** for Oven
239D (Full) / 239C (Semi)

Product Size

Width (W) : (Min) 450 - (Max) 600mm
Depth (D) : 587 mm
Height (H) : 760 mm

Full Aluminium Cabinet Series





6 **3 Drawers**
241D (Full) / 241C (Semi)

Product Size

Width (W) : 450 / 600 / 900 mm
Depth (D) : 587 mm
Height (H) : 760 mm



7 **2 Drawers**
242D (Full) / 242C (Semi)

Product Size

Width (W) : 450 / 600 / 900mm
Depth (D) : 587 mm
Height (H) : 760 mm



8 **2 Drawers**
243D (Full) / 243C (Semi)

Product Size

Width (W) : 450 / 600 / 900 mm
Depth (D) : 587 mm
Height (H) : 760 mm



9 **3 Drawers N/A**
244D (Full) / 244C (Semi)

Product Size

Width (W) : 450 / 600 / 900 mm
Depth (D) : 587 mm
Height (H) : 760 mm



10 **Corner with 1 Door (Left)**
291H (Full) / 291F (Semi)

Product Size

Width (W) : 1052 mm
Depth (D) : 587 mm
Height (H) : 760 mm



11 **Corner with 1 Door (Right)**
292H (Full) / 292F (Semi)

Product Size

Width (W) : 1052 mm
Depth (D) : 587 mm
Height (H) : 760 mm

Types of Model

Wall Cabinet

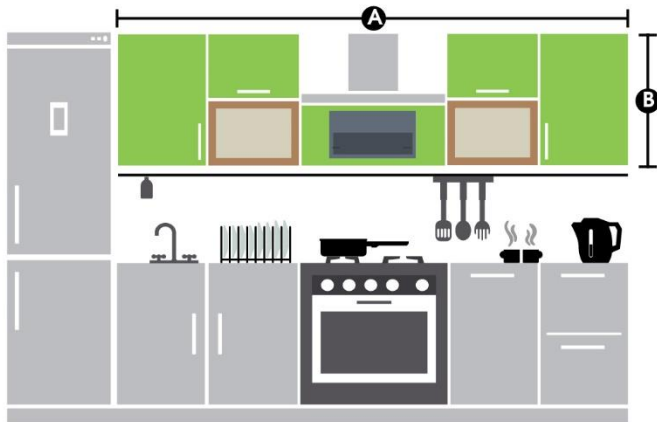

A Width : Custom Size

B Height : 760 mm

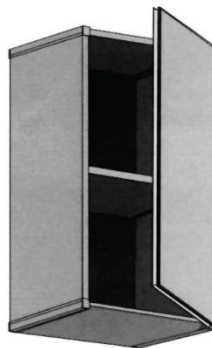

12 1 Door
211D (Full) / 211C (Semi)

Product Size

Width (W) : 450 mm
Depth (D) : 352 mm
Height (H) : 760 mm

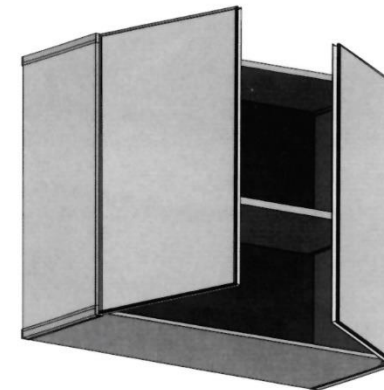

13 2 Door
232D (Full) / 232C (Semi)

Product Size

Width (W) : 900 mm
Depth (D) : 352 mm
Height (H) : 760 mm

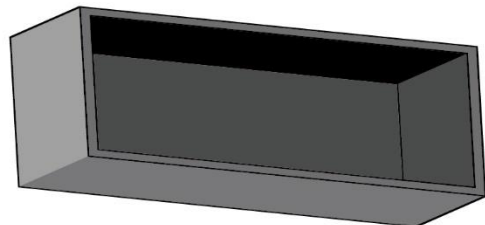

14-A Open without door
221D (Full) / 221C (Semi)

Product Size

Width (W) : (Min) 450 - (Max) 900mm
Depth (D) : 352 mm
Height (H) : 380 mm

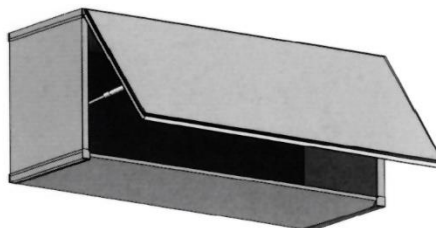

14 1 Horizontal
221D (Full) / 221C (Semi)

Product Size

Width (W) : (Min) 450 - (Max) 900mm
Depth (D) : 352 mm
Height (H) : 380 mm

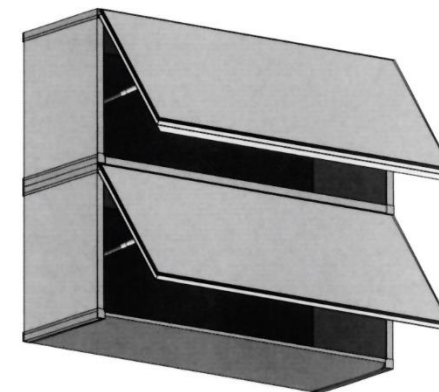

15 2 Horizontals
222D (Full) / 222C (Semi)

Product Size

Width (W) : (Min) 600 - (Max) 900 mm
Depth (D) : 352 mm
Height (H) : 380 mm

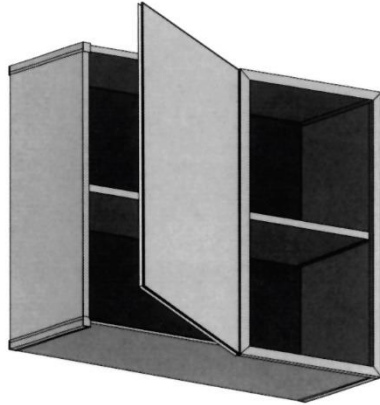

16 **Corner with 1 Door (Left)**
291G (Full) / 291E (Semi)

Product Size

Width (W) : 1052 mm
Depth (D) : 352 mm
Height (H) : 760 mm

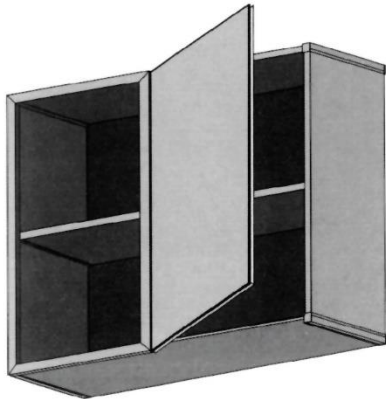

17 **Corner with 1 Door (Right)**
292G (Full) / 292E (Semi)

Product Size

Width (W) : 1052 mm
Depth (D) : 352 mm
Height (H) : 760 mm



Types of Model Tall Cabinet



A Width : Custom Size **B** Height : 2060 / 2560 mm

C Bottom Skirting Board (H) : 100mm

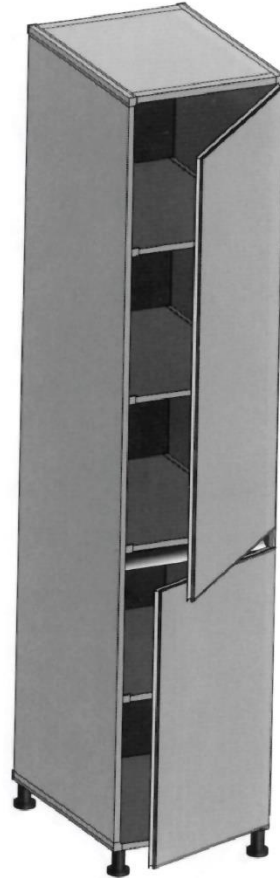

18 5 Shelves
251D (Full) / 251C (Semi)

Product Size

Width (W) : 600 / 900 mm
Depth (D) : 587 mm
Height (H) : 2060 / 2560 mm

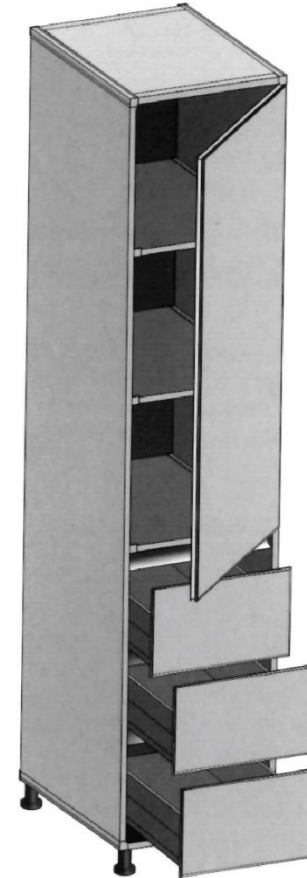

19 3 Shelves + 3 Drawers
252D (Full) / 252C (Semi)

Product Size

Width (W) : 600 / 900 mm
Depth (D) : 587 mm
Height (H) : 2060 / 2560 mm

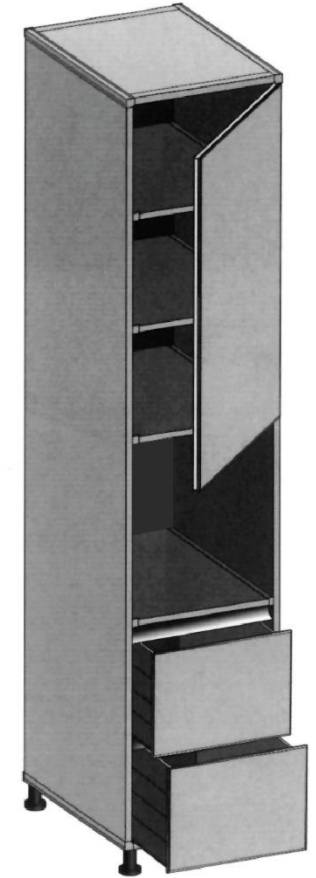

20 for Oven with
4 Shelves + 2 Drawers
253D (Full) / 253C (Semi)

Product Size

Width (W) : 600 / 900 mm
Depth (D) : 587 mm
Height (H) : 2060 / 2560 mm

Drawers Standard Width

This is our standard width of drawers for your quick & convenient selection process.

Model	Standard Width		
	450 mm	600 mm	900 mm
3 1 Door + 1 Drawer 233D (Full) / 233C (Semi)	●	●	
4 2 Doors + 1 Drawer 234D (Full) / 234C (Semi)		●	●
6 3 Drawers 241D (Full) / 241C (Semi)		●	●
7 2 Drawers 242D (Full) / 242C (Semi)		●	●
8 2 Drawers 243D (Full) / 243C (Semi)		●	●
9 3 Drawers 244D (Full) / 244C (Semi)		●	●
19 3 Shelves + 3 Drawers 252D (Full) / 252C (Semi)		●	●
20 for Oven with 4 Shelves + 2 Drawers 253D (Full) / 253C (Semi)		●	●



Types of Cabinet Door

Finger Groove Cabinet Door

- Hassle-free to operate.
- Durable and easy to clean.
- Sleek and seamless facade.
- Fit in for all design styles - from traditional to contemporary.



Applicable to 3.4 mm Panel

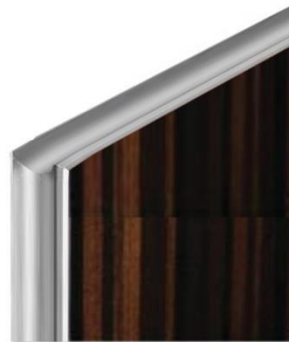
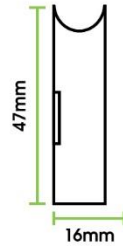

Frame Colour

N A

SBG

CD 113 (LG)

Applicable to 3.4 mm Panel

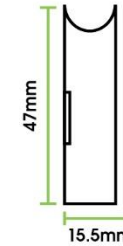

Frame Colour

N A

SBG

CD 109 (CG)

Applicable to 3.4 mm Panel & VACP

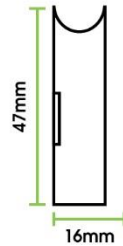

Frame Colour

N A

SBG

CD 111 (CG)

Applicable to 4 mm Glass Panel

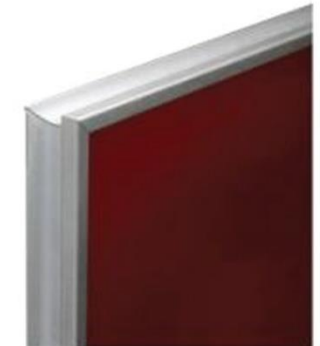
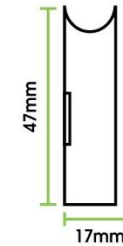

Frame Colour

N A

SBG

CD 115 (CG)

A kitchen that is perfect down to the last detail Add on Accessories

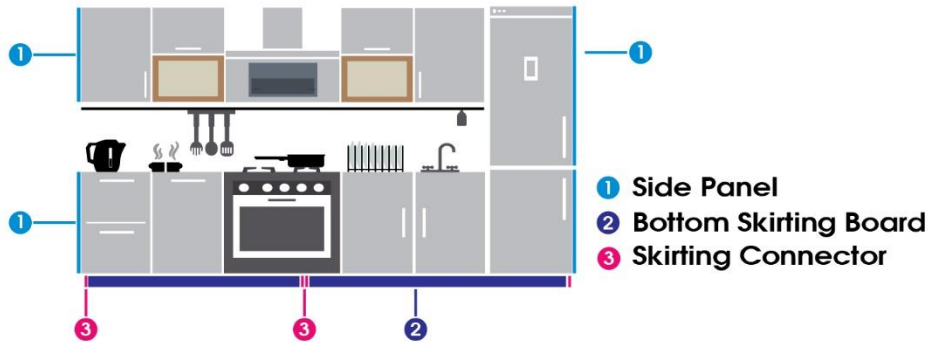

1 Side Panel

EPS Co. Kitchen Cabinet is built to be viewed from all angles! You will be amazed at what a big impact the side panel can help to get the desired look of your kitchen.



2 Bottom Skirting Board

The Aluminium skirting board is a very decorative board for creating an attractive and modern transition between wall and floor. A toe-kick is a helpful little ergonomic detail of the kitchen cabinets. Installation of bottom skirting board is fantastic for concealing purposes and will be the perfect finishing touch for your dream kitchen.

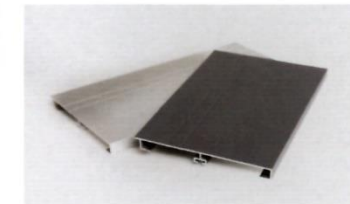
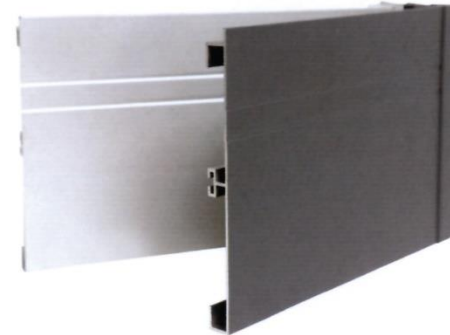

Standard Size
Width (W) : 10mm (Max)
Height (H) : 100mm
Length (L) : 401mm

Side View

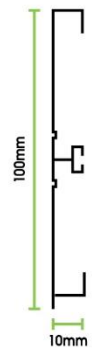

3 Skirting Connector

A skirting connector is designed for variable degree connections ensuring a precise joint and smooth finish.



Standard Size
Width (W) : 250mm (Max)
Height (H) : 150mm

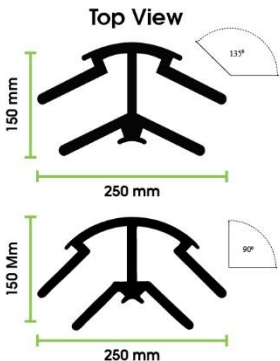

Panel Available

Specification

Size : 1220 X 2440 mm
 Thickness : 3 mm
 Surface Finishing : Solid Colour with matt surface
 Wood-grain with texture surface

- 
Textured Surface
- 
Double-faced
- 
High Density
- 
Impact Resistance
- 
Balance Thickness
- 
Heat Resistance
- 
Water Resistance
- 
Anti Termites
- 
Easy to clean

STRUCTURE

Multiple layers are bonded at high pressure & temperature

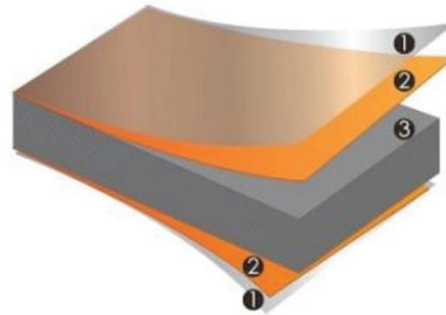

- ① Protective tissue overlay
- ② Decorative paper layer
- ③ Kraft paper layer

PANEL COLOURS

Solid colours and Wood-grain with different visual effect for selection.

Solid Colours



Wood-grain



Specifications

Full Aluminium Cabinet Series

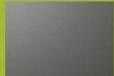
No.	Types of Cabinet	Model	Width	Fixed Size (Depth & Height)	Types of Cabinet Door	Infill Panel	Featured Accessories	Add on Accessories	Frame Colour
1	Base Cabinets	231D	450/600 mm	587 X 760 mm	<ul style="list-style-type: none"> CD 109 CD 111 CD 113 CD 115 	<ul style="list-style-type: none"> Panel Lamina Glass Panel Aluminium Composite Panel 	<ul style="list-style-type: none"> Height Adjustable Leg (BCL-01) Separator Pin (SP-02) Screw Cover (30857) 	<ul style="list-style-type: none"> Side Panel Bottom Skirting Board (30843) Skirting Connector (30844) 	 Natural Anodised
2		232D	600 - 900 mm						
3		233D	450 / 600 mm						
4		234D	600 / 900 mm						
5		239D	450 - 600 mm						
6		241D	450 / 600 900 mm						
7		242D							
8		243D							
9		244D							
10		291H	1052 mm						
11		292H							
12	Wall Cabinets	211D	450 - 600 mm	352 X 760 mm	<ul style="list-style-type: none"> CD 109 CD 111 CD 113 CD 115 	<ul style="list-style-type: none"> Panel Lamina Glass Panel Aluminium Composite Panel 	<ul style="list-style-type: none"> Height Adjustable Leg (BCL-01) Separator Stopper (30857) Profile Cover (30857) 	<ul style="list-style-type: none"> Side Panel 	 Powder Coating Sandblast Gray
13		212D	600 - 900 mm	352 X 380 mm					
14		221D							
15		222D							
16		291G	1052 mm						
17		292G							
18		Tall Cabinets	251D	600 - 900 mm			587 X 2160 / 2660 mm		
19	252D		600 / 900 mm						
20	253D								

Specifications

Semi Aluminium Cabinet Series



Made in K.S.A صنع في السعودية

No.	Types of Cabinet	Model	Width	Fixed Size (Depth & Height)	Types of Cabinet Door	Infill Panel	Featured Accessories	Add on Accessories	Frame Colour
1	Base Cabinets	231C	450 - 600 mm	587 X 760 mm	<ul style="list-style-type: none"> CD 109 CD 111 CD 113 CD 115 	<ul style="list-style-type: none"> Panel Lamina Glass Panel Aluminium Composite Panel 	<ul style="list-style-type: none"> Height Adjustable Leg (BCL-01) Separator Pin (SP-02) Screw Cover (K-902) 	<ul style="list-style-type: none"> Side Panel Bottom Skirting Board (30843) Skirting Connector (30844) 	 <p>Natural Anodised</p>
2		232C	600 - 900 mm						
3		233C	450 / 600 mm						
4		234C	600 / 900 mm						
5		239C	450 - 600 mm						
6		241C	450 / 600 900 mm						
7		242C							
8		243C							
9		244C							
10		291F	1052 mm						
11		292F							
12	Wall Cabinets	211C	450 - 600 mm	352 X 760 mm	<ul style="list-style-type: none"> CD 109 CD 111 CD 113 CD 115 	<ul style="list-style-type: none"> Panel Lamina Glass Panel Aluminium Composite Panel 	<ul style="list-style-type: none"> Height Adjustable Leg (BCL-01) Screw Cover (K-902) 	<ul style="list-style-type: none"> Side Panel 	 <p>Natural Anodised</p>
13		212C	600 - 900 mm	352 X 760 mm					
14		221C							
15		222C							
16		291E	1052 mm	352 X 760 mm					
17		292E							
18		Tall Cabinets	251C	600 - 900 mm			587 X 2160 / 2660 mm		
19	252C		600 / 900 mm						
20	253C								

للألومنيوم
Aluminium

إب إس
EPS

Made in K.S.A صنع في السعودية

Diaa M Al-Tabbaa

General Manager , EPS Aluminium Co.

Mobile: +966505538894, Tel : +966-12-6776440 Ext 222

P.O. Box 126874 – Jeddah 21352 , King Faisal Rd. AL Dahiya Jeddah, K.S.A

Email: diaa@EPSCO.SA , Web Site : <http://www.epsco.sa>

2020 - 2021