

EPS  
إيس للإلتيموم





## Who We Are

Is a leading construction, project management contractor, and specialized in steel structure, cladding and aluminum glazing. Our reputation for safety delivering quality projects on time and budget is well recognized in the industries we serve. We have proven expertise in managing large complex projects and strong relationship with our clients.

السادة عملائنا الكرام يشرفنا نحن شركة إيس للألمنيوم في تقديم أفضل الخدماتنا فيما يتعلق بالمشاريع الخاصة بكم من حيث تقديم أفضل الحلول التقنية بمجال صناعة الألمنيوم والمعادن بكافة المجالات من حيث تصميم بروفيلات الألمنيوم و سحب قطاعات من أفضل شركات سحب الألمنيوم بالمملكة العربية السعودية و كذلك ينطبق على جميع المعادن حسب طلب مكاتب الاستشارية سواء من داخل المملكة أو من خارجها .. و نحن لدينا قسم تطوير المنتجات الألمنيوم و المعادن حتى يتم مواكبة التطورات الدائمة في هذا المجال. بالختام يسعدنا و يشرفنا خدمتكم

## What We Do

EPS has been constructing projects. Steel structure and Cladding & Glazing for the construction industry.

Over a few years, we have developed and established good business relations with several private and governmental clients.

EPS specializes in the Steel structure. Aluminum Cladding, Structural Glazing. Curtain wall and all kinds of Storefront Doors to better serve our clients we have acquired new technology that is capable of our business however, extends to other parts of Middle East.



## Services

1. General Contracting
2. Steel Structure
3. Aluminum & Structural Glazing
4. Cladding Works

EPS has been constructing High quality aluminium windows.

**Specifications :**

Aluminium profile, thickness 2mm water and dust repellent with the possibility of installing an external roller shutter and ensuring that dust and air do not enter. Specializes in the all kinds of windows to better serve our clients we have acquired new technology that is capable of our business however, extends to other parts of Middle East.



# ALUMINIUM WINDOWS

EPS  
إيس للإلتيموم



EPS has been constructing High quality aluminium doors.

**Specifications :**

Aluminum doors of high quality and specification of EPS company from the outside a layer of HPL and from the inside. The filling is made of fire retardant PVC and water-resistant five-year quality guarantee Italian made accessories. The door lock is the same as the wood doors, with the possibility of installing a smart system. We also have a central lock for exterior doors. The possibility of installing glass in several forms that are resistant to breakage.





COMPANY  
EXPERIENCE AND  
CAPABILITIES  
**CONTRACTING**



**OUR  
RESOURCES**



## COMPANY STRUCTURE

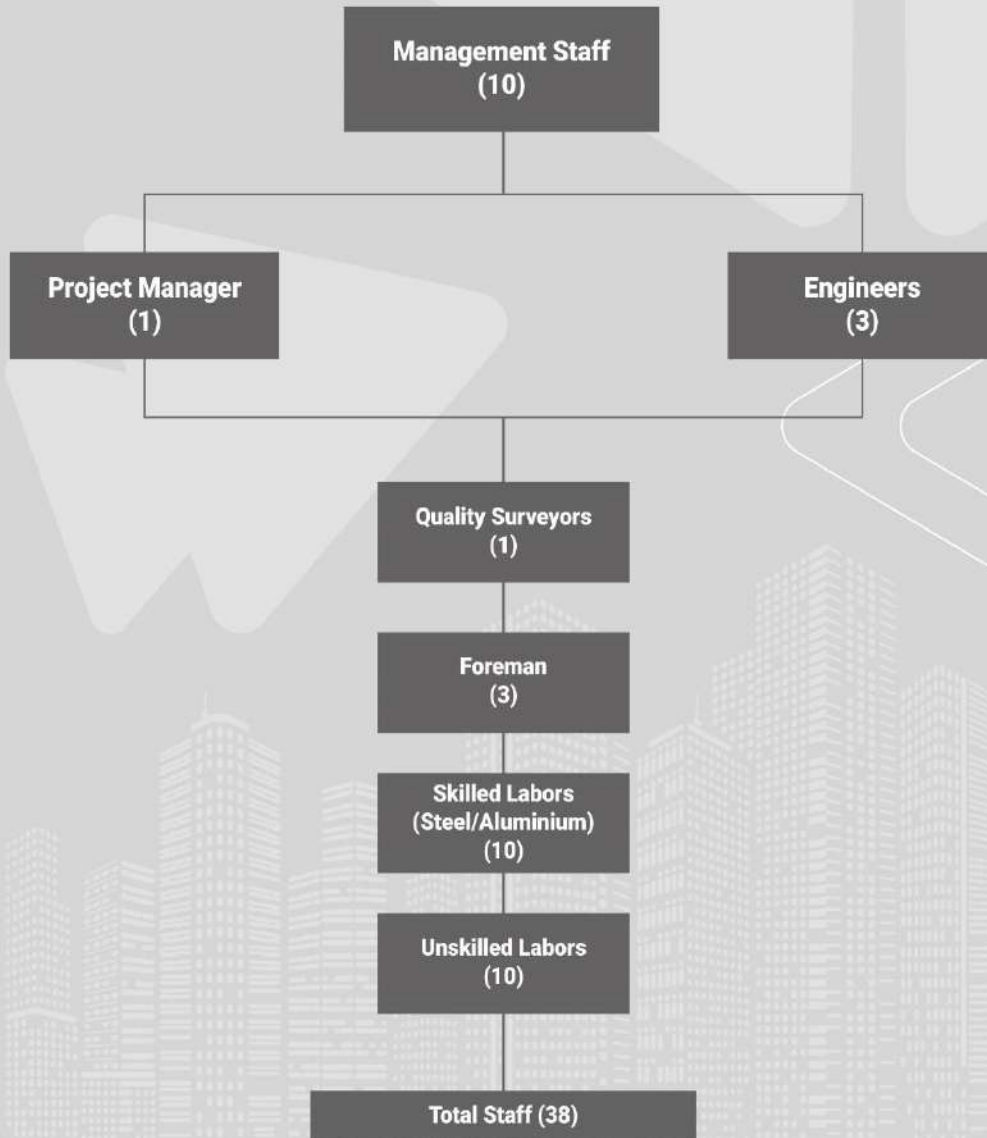

## LIST OF EQUIPMENT

EQUIPMENT	QUANTITY
Aluminum cutting saw	2
Automatic aluminum angle saw	1
CNC aluminum punching machine, 7m long	1
Manual aluminum cutting saw	2
Aluminum punching and milling press	1
Manual aluminum milling machine	3
Ordinary iron cutting saw	1
Aluminum bracket winding machine	1
CNC Wood and Aluminum Router Machine	1
CNC Wood Planing Machine	1
NC . Wood Punching Machine	1
NC . Blade and Wood Cutting Saw	1
Aluminum corner press machine	1
Grinding Machine	1
Micro Bus Nissan	1
Coaster Bus Nissan	1
Compressor	2
Hyundai dyna	1

## COMPUTER AND EQUIPMENT LIST

S.No.	DESCRIPTION	UNIT	QUANTITY
1	Computer Desktop	Set	25
2	Laptop	Set	02
3	Computer Printer	Set	10
4	Computer Server	Set	2

S.No.	SOFTWARES
1	Microsoft Office (Excel, Powerpoint, Word, Outlook, Publisher)
2	Primavera
3	AutoCAD 2016
4	Revit Building
5	Sketchup Pro + Vray Render
6	3Ds Max + Vray Render
7	Adobe Photoshop
8	Dreamweaver
9	Adobe Flash
10	Corel Draw 17

S.No.	DESCRIPTION	UNIT	QUANTITY
1	Fax Machine	Set	3
2	Xerox Copier Machine	Set	4
3	Telephone Trunk Line	Set	13
4	LCD Projector	Set	2
5	Office Table	Set	26
6	Office Chairs	Set	40
7	Conference Table	Set	2
8	Sala Set for Reception Area	Set	3
9	Sunbird Finger print attendance	Set	2
10	Water Dispenser	Set	5
11	Filling Cabinet	Set	18
12	Binding Machine	Set	2

## LMX 650 ALUMINUM PROFILE PROCESSING CENTER



Machining and cutting line with down-feed blade  $\varnothing$  650 mm and bar passage 300x300 mm

The machining unit LMX 650 tooled up with max 18 electrospindles and the cutting unit with infinite 360° blade rotation produce a continuous flow of processed and cut to measure elements. The additional machining module XMU carries out end milling (with blade, mill or mill units), boring and head tapping, as well as 45° and 135° inclined cuts, guaranteeing maximum flexibility for numerous applications. The high visibility cabin and the presence of the luminous FOM logo indicating the machine status are characteristic of the futuristic design of the system of LMX 650.

6 different variants are available, which can be configured in terms of length of material loading/unloading magazines and feed direction.

# Future Aluminium Profile LMX 650





Elumatec Dg 244 d'occasion  
à vendre sur Machinesseeker



Direct Industry  
Sega monotesta  
REKTA - ABCD MACHINERY S.r.l.



Machine-64-122-left-view-of-elumatec-sbz



XYZ PANELBuilder 5022 - CNC Router  
600X200 CM

# Aluminium Cladding System



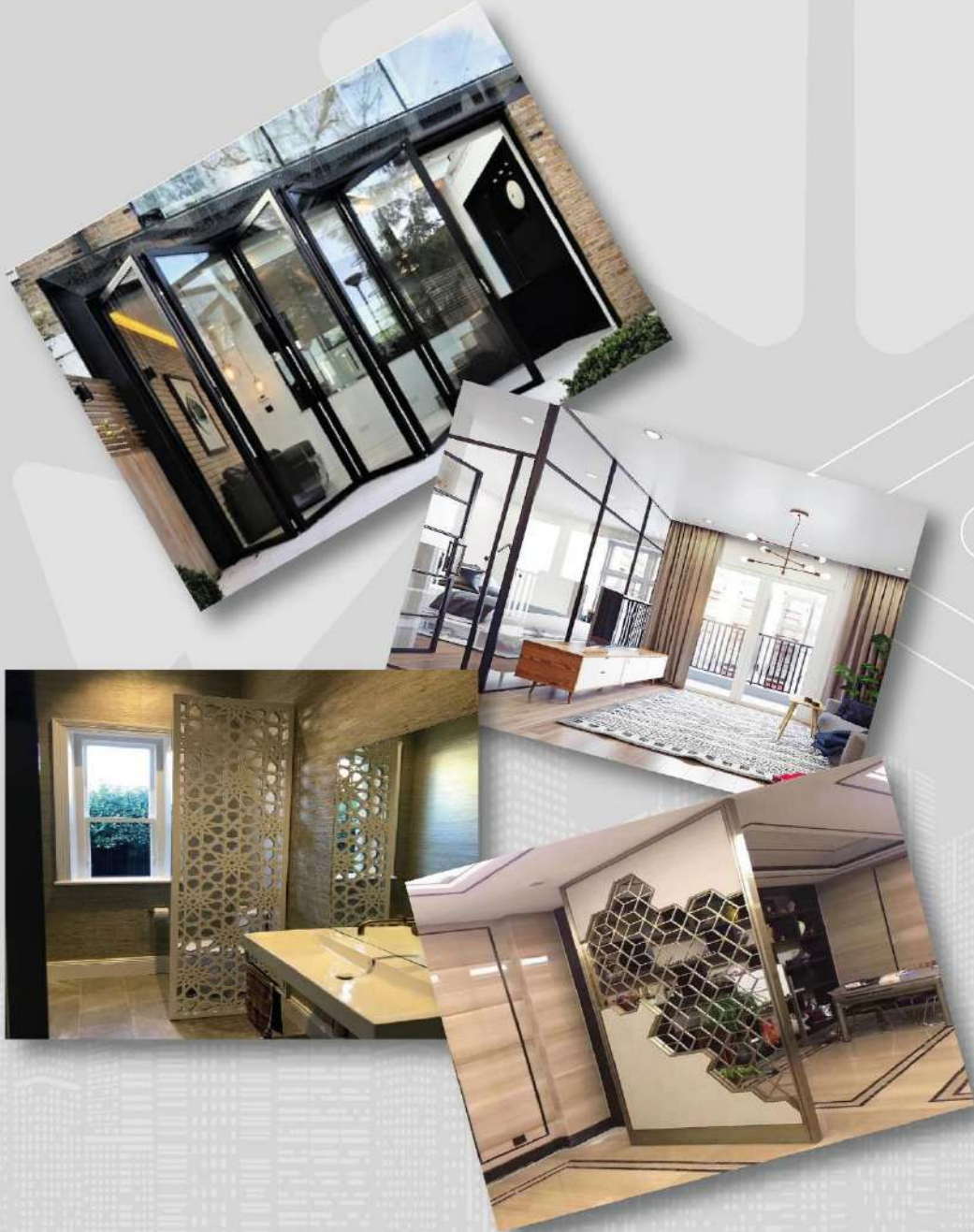



# Internal Partition Aluminium & Glass





# LASER CUTTING MACHINE

EPS  
إس إس إن

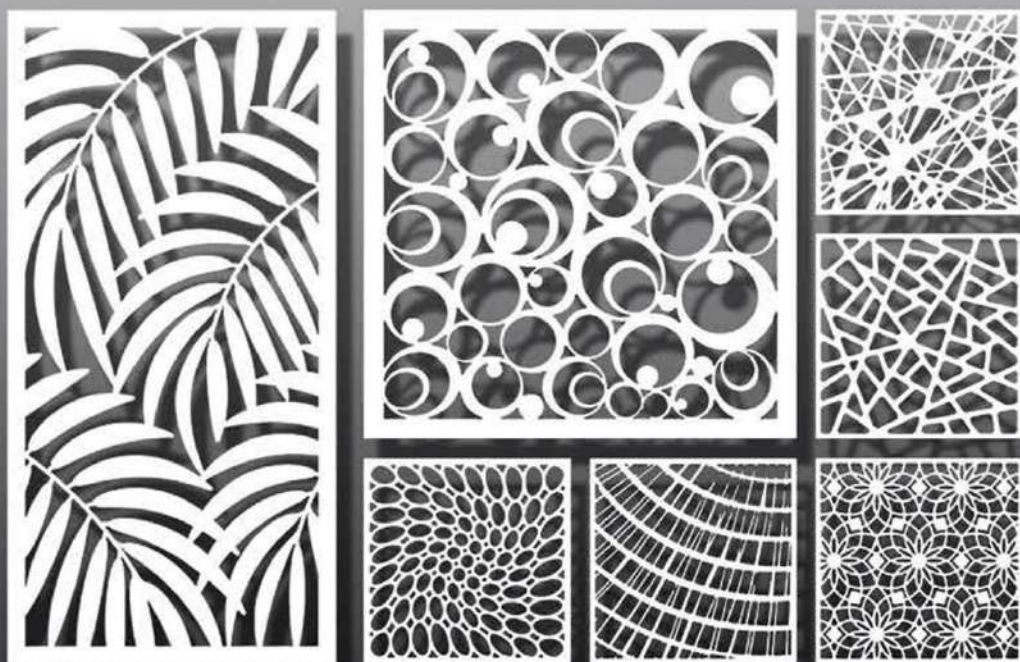

**THE FIRST OWNER OF THE  
PROJECT IS A BASIC PARTNER  
OUR SUCCESS**



## OUR PARTNERS IN SUCCESS





## CONCEPT FOLDING 77

Invite nature into your building

**R**  
REYNAERS  
aluminium

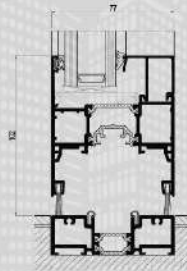

People are continuously looking for ways to maximize their space, as well visually as physically. The Concept Folding<sup>®</sup> 77 offers them the opportunity to optimize the utilization of their rooms, drawing the external environment into their homes. Next to the improved space utilization, this innovative system offers the advantage of loads of daylight coming in, as well as an aesthetical design. Another practical feature of CF 77 is the optional door locking principle which allows to use the first leaf as an entrance door without affecting the folding capacity of the system.

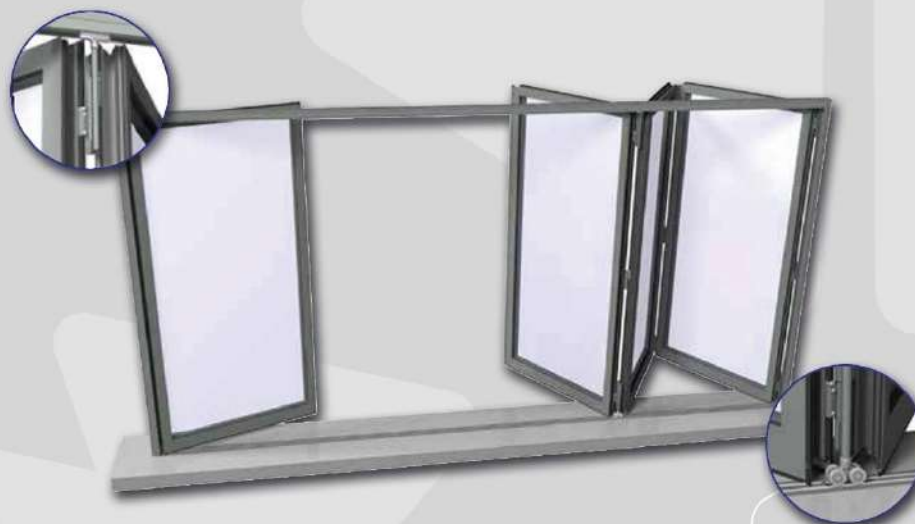

Innovative functional and technical features:

With CF 77, design and user friendliness go hand in hand with high technical performance. The standalone solution exists out of new profiles, accessories and insulation technologies that have specifically been designed for folding systems. It ensures high insulation values ( $U_f$  values down to 2,25 W/m<sup>2</sup>K) that meet stringent local legislation requirements as well as market demands. Available in a number of configurations using between 2 and 8 door leaves, you can choose a design where the complete set of vents stacks to the same side, or split the design at any position, possibly integrating a central door solution.

**Innovative functional and technical features:**

- Highly thermally insulating
- Water resistance up to 600 Pa
- Glazing up to 63 mm
- 2 to 8 vent combinations
- Burglar resistant variant
- Large vent sizes
- High vent weights
- In - and outward opening using the same profiles
- Window or door functionality for the first vent
- Integrated and centrally built-in bottom rolling system

	Max. vent size (mm)	Max. vent weight	Uw (W/m <sup>2</sup> K) *	Uf (W/m <sup>2</sup> K)	Visible width vent-vent sect.
Reynaers CF 77	1200x3000	120 Kg.	down to 1,66	down to 2.25	144 mm
Reynaers CF -77SL	1200x3000	120 Kg.	down to 1,64	down to 2.31	122 mm
Reynaers CF -77AP	1200x3000	120 Kg.	down to 1,66	down to 2.25	144 mm
Reynaers CF -77SL/AP	1200x3000	120 Kg.	down to 1,64	down to 2.31	122 mm

\* Ug: 1,1 W/m<sup>2</sup>K  
 -4panel: 4000 x 2700 mm  
 شركة إيس للإلمنيوم  
 EPS Aluminum Co.

Next to the functional design, the CF 77 is supplemented with a Slim-Line variant, the CF -77SL, featuring a narrower visible width. Both designs are available in four different door sill solutions: High Performance, Double Weather Seal, Low Threshold and Flat Bottom Solution. The High Performance option offers maximum performance in terms of air, wind and water resistance. The Double Weather Seal solution combines good air, wind and water resistance with decreased threshold and is well suited for renovation projects. The Low Threshold option offers a rise of only 18 mm and finally the Flat Bottom solution allows easy passage and maximum convenience for high traffic.

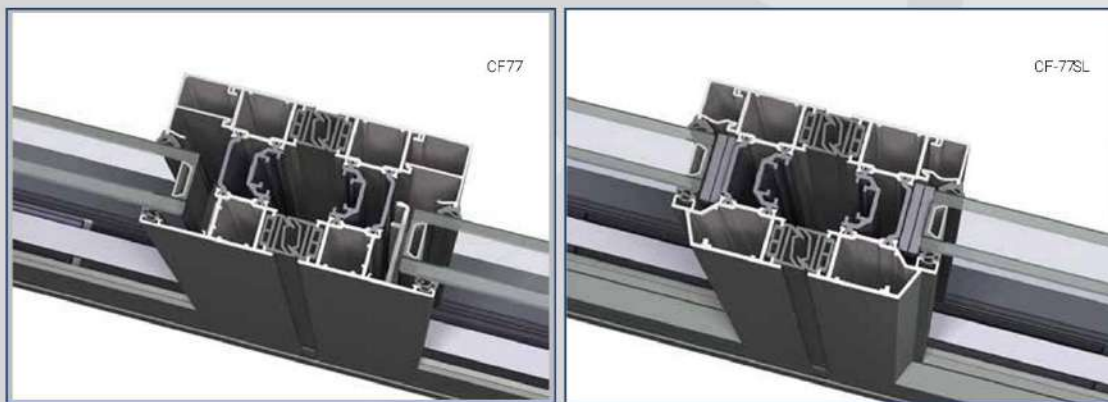

4 different threshold solutions meeting functional needs and performance levels:

		Flat Bottom	Low Threshold	Double Weather Seal	High Performance
	Air tightness	Not applicable	Class 2	Class 2	Up to Class 4
	Wind load resistance	Not applicable	Class B2	Class B2	Up to Class B3
	Burglar Proof*	RC2	RC2	RC2	RC2
	Water tightness	Not applicable	Class 4A (150 Pa)	Class 5A (200 Pa)	Up to Class 9A (600 Pa)
		- Optimal accessibility - Aesthetic bottom solution - Economical solution	- Easy passing (18mm threshold) - Elementary AWW rating - Weather Seal	- Double Weather Seal - Suitable for renovation	- High Performance - Double Weather Seal - 3 different performance levels in one profile

\*The burglar proof classification is in accordance with EN601627



# DECORATION





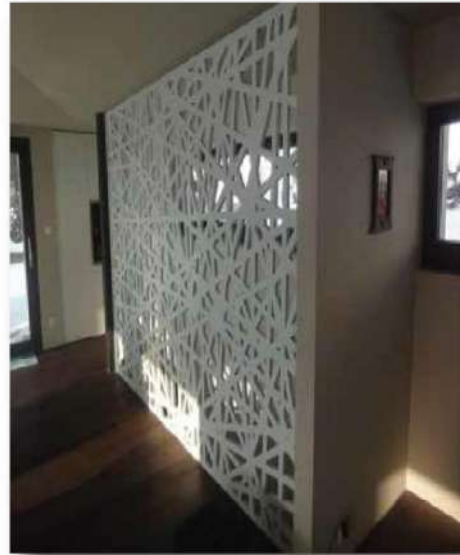























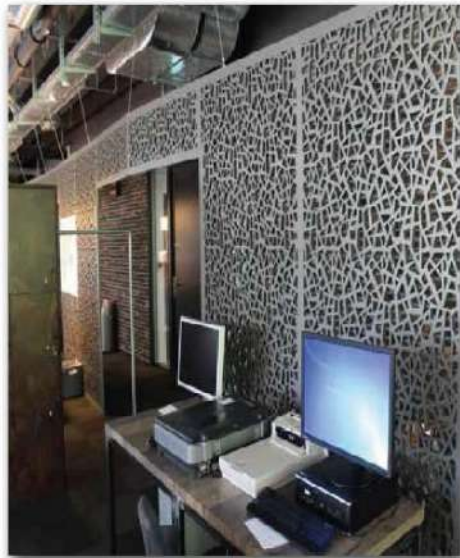









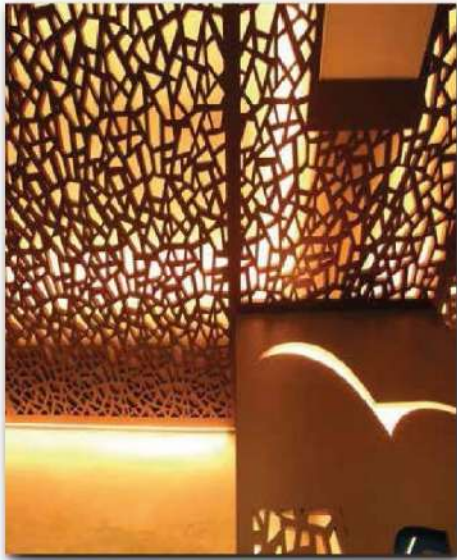



**ALUMINIUM MOVEABLE SYSTEM**

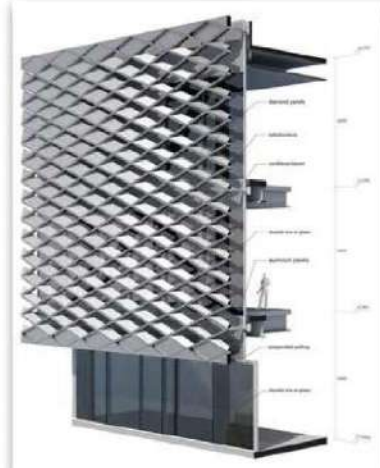

**BUILDING FACADE  
ALUMINIUM  
DECORATION**



**BUILDING FACADE  
ALUMINIUM DECORATION**



**BUILDING FACADE  
ALUMINIUM DECORATION**

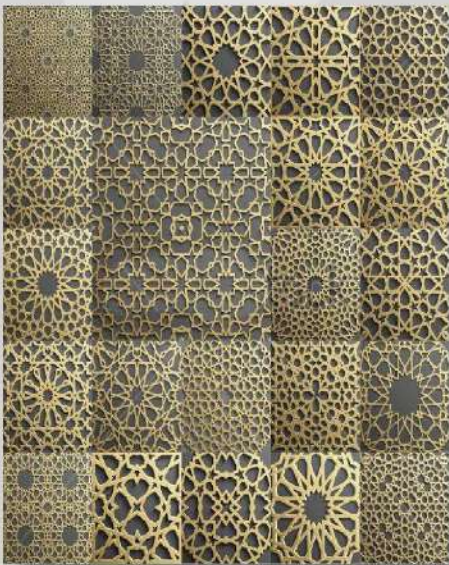

## ALUMINIUM SKYLIGHT SYSTEM

EPS  
إيس للإلمنيوم



**Aluminium Skylight System round domes sizes untill  
30 meter - system that prevents water leakage  
self cleaning system & lighting**

**STEEL CANOPY TOP GLASS**



**CNC PERFORATION**



**CNC PERFORATION**



**CNC PERFORATION**



**FOLDING ALUMINIUM & GLASS DOOR**  
**100% SAUDI MADE**



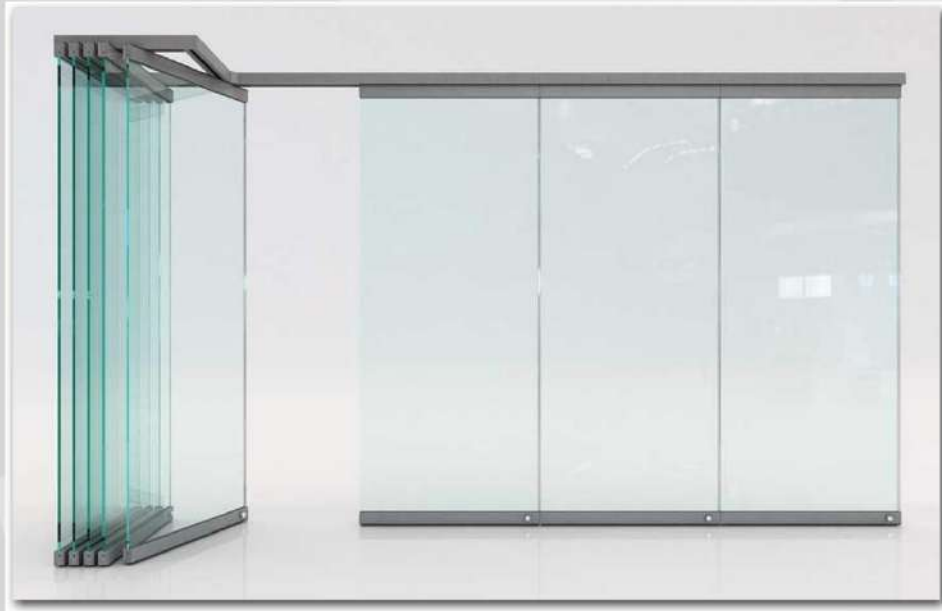



ALUMINIUM ROUND DOOR  
AUTOMATIC & MANUAL









# EXTERIOR STRUCTURE

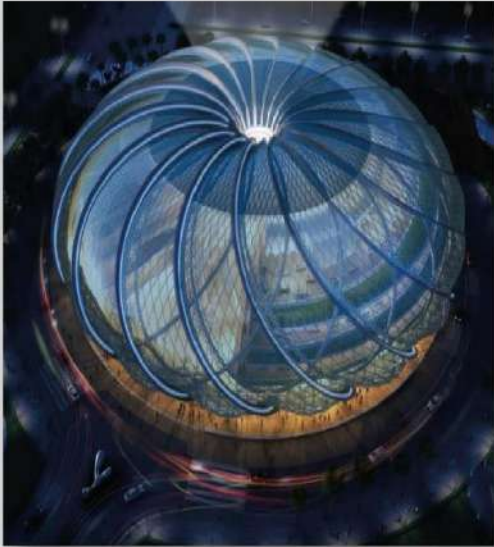



# LASER CUTTING DECORATION







## ALUMINIUM COMPOSITE PANELS (ACP)



Currently, aluminum composite panel can be transformed in many ways. Among them are punching, which allows the creation of pointy-type shapes on the surface of the panel, creating drawings or forms; roller bending, to achieve curved shapes; CNC stamping and engraving to create reliefs; 3D shaping to project volumes on a flat surface, etc.

This transformation capacity of the aluminium composite panel gives it a plus of versatility in order to being used for constructing risky and creative designs.

It also makes it an ideal material to combine and make the areas of the facade which would be impossible with other kind of materials.

Beyond the usual picture of a ventilated flat facade, we see how the panel can be used for other more striking projects and risky designs that contribute to give a special character to the buildings.





 الرقم الواسع: 3070/06/70  
 الرقم الضريبي: 310705738

 الهيئة العامة للزكاة والدخل  
 General Authority of Zakat & Tax

**ضريبة القيمة المضافة**  
**VAT**

**شهادة تسجيل في ضريبة القيمة المضافة**  
**VAT Registration Certificate**

تشهد الهيئة العامة للزكاة والدخل بأن المكلف أدناه مسجل في ضريبة القيمة المضافة بتاريخ 2020/12/14

Hereby, The General Authority of Zakat & Tax (GAZT) certifies that the taxpayer below is VAT registered on 14/12/2020

<b>Taxpayer Name:</b>	شركة إيس للإئتميم	<b>اسم المكلف:</b>
<b>VAT Registration Number:</b>	31070573800003	<b>رقم التسجيل الضريبي:</b>
<b>Effective Registration Date:</b>	2020/01/01	<b>تاريخ نفاذ التسجيل:</b>
<b>Taxpayer Address:</b>	صحة جدة البحر سلطان 23525	<b>عنوان المكلف:</b>

 كل مكلف مسجل في ضريبة القيمة المضافة لا يجوز له تخصيص ضريبة القيمة المضافة من عملياته قبل تاريخ نفاذ التسجيل بالضريبة، في حال تبين عدم ذلك يتقدم الهيئة العامة للزكاة والدخل بتفقد البيانات المستحقة

**هذه الوثيقة مرسلة من النظام الآلي ولا تحتاج إلى توقيع**  
**– الهيئة العامة للزكاة والدخل –**

 الرقم الواسع: 3070/06/70  
 الرقم الضريبي: 310705738

 الهيئة العامة للزكاة والدخل  
 General Authority of Zakat & Tax

**ضريبة القيمة المضافة**  
**VAT**

**اسم المكلف:** شركة إيس للإئتميم

**رقم السجل/الرخصة/العقد:** 403339534

**الفترة الضريبية:** ربع سنوي/Quarterly

**تاريخ استحقاق أول إقرار ضريبي:** 2021/04/30

**First Filing due date:** 2021/04/30

 كل مكلف مسجل في ضريبة القيمة المضافة لا يجوز له تخصيص ضريبة القيمة المضافة من عملياته قبل تاريخ نفاذ التسجيل بالضريبة، في حال تبين عدم ذلك يتقدم الهيئة العامة للزكاة والدخل بتفقد البيانات المستحقة

**هذه الوثيقة مرسلة من النظام الآلي ولا تحتاج إلى توقيع**  
**– الهيئة العامة للزكاة والدخل –**



رؤية  
2030  
الجمهورية العربية السعودية  
KINGDOM OF SAUDI ARABIA

## ترخيص منشأة صناعية

### استثمار وطني



١٤٤٢-١٢-٠١ تاريخ القرار ١٤٤٢-١٢-٠١ تاريخ الترخيص  
١٤٤٣-١١-١٨ تاريخ الانتهاء ٤٢١١٠٢١١٣٣٣ رقم القرار ١٠٠١١١٧٤ رمز المنشأة  
تعديل نوع القرار

اسم المنشأة الصناعية شركة إيس للإلتصوم  
السجل التجاري للمنشأة الصناعية ٤٠٢٠٢٨٩٥-٤  
مالك المنشأة شركة إيس للإلتصوم  
رقم السجل التجاري الرئيسي ٤٠٢٠٢٨٩٥-٤  
النشاط الرئيسي صنع الأثاث / ٣١٠٠

هاتف +٩٦٦٥-٧٥٥٢٢٩٤  
فاكس  
موقع المنشأة الصناعية (N21\_31 B329754693647 ,E39.20315469221227)  
المنطقة منطقة مكة المكرمة  
المدينة جدة

عدد العمالة ٤٠  
حجم الاستثمار ١٥٠٠٠٠٠٠٠٠  
أربعون فرداً  
مليون و خمسمائة ألف ريال

رمز المنتج	وصف المنتج	النشاط الصناعي	الطاقة الإنتاجية	الوحدة
٧٦١٠٩٠٦٠	مطابخ وخواتمات المنيوم	٣١٠٠٢٢ / صناعة الأثاث من الألمنيوم لمختلف الأغراض والاستخدامات	١٥٠٠٠٠	متر طولي
٩٤٠٢١٠٦٠	مطابخ المنيوم	٣١٠٠٧٠ / صناعة المطابخ من الخشب والألمنيوم الخ	٧٥٠٠٠٠	متر طولي
٩٤٠٣١٠٦٠	أثاث خشبي متنوع	٣١٠٠١٠ / صناعة الأثاث والموبيليا من الخشب	١٠٠٠٠٠٠	متر مربع
٩٤٠٤١٠٦٠	مطابخ خشبية	٣١٠٠٧٠ / صناعة المطابخ من الخشب والألمنيوم الخ	٥٠٠٠٠٠٠	متر طولي

وزير الصناعة والثروة المعدنية

بتدر بن إبراهيم الخريف





## رخصة نشاط تجاري Commercial Activity Licence شركة ايس للألمنيوم

License Expiry Date	تاريخ نهاية الترخيص	License Number	رقم الرخصة الموحّد
1443/10/27		42105632282	

Owner's Name	اسم المالك
شركة ايس للألمنيوم	

Owner's ID	رقم هوية المالك
4030389504	

ISIC Classification	التصنيف الصناعي القياسي الدولي (نشاط أيزك)
صناعة المطابخ من الخشب والألمنيوم	

Detailed Activity	النشاط التفصيلي
صناعة المطابخ من الخشب والألمنيوم الخ	

Sub-Municipality	البلدية	Municipality	الأمانة
بلدية المليساء الفرعية		أمانة محافظة جدة	

Street	الشارع	District	الحي
ابو السلامة		الضاحية	

Shop's Sign's Area	مساحة اللوحات الإعلانية	Shop's Total Area	مساحة المحل الإجمالية
3 متر مربع إرشادي   0 متر مربع إعلاني		2952 متر مربع	



موقع المحل

لتطلاع على الأنشطة الإضافية وتفاصيل الرخصة يرجى مسح رمز الاستجابة السريع QR Code

Permit Expiry Date	تاريخ انتهاء التصريح	Permit Number	رقم التصريح	Permits	التصاريح
--------------------	----------------------	---------------	-------------	---------	----------

مركز الدعم الفني  
199099

هذا الترخيص لا يحول البدء بالإنتاج إلا بعد الحصول على تراخيص الجهات ذات العلاقة

sauidimomra

www.balady.gov.sa



## **Diaa M Al-Tabbaa**

General Manager EPS Aluminium Co.

Mobile: +966505538894, Tel : +966-12-6776440 Ext 222

P.O. Box 126874 – Jeddah 21352,

King Faisal Rd. AL Dahiya Jeddah, Kingdom of Saudi Arabia

Email: [diaa@EPSCO.SA](mailto:diaa@EPSCO.SA)

Web Site : <http://www.epsco.sa>

